

Hardware Instructions for North Star Series Collectors: MT-TM-SC (Tilt Mount)

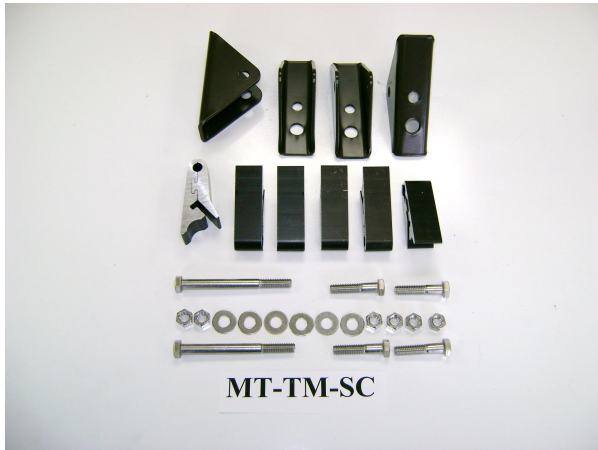

The Tilt Mount hardware is shipped in sets of two front mount and two rear mounts, enough hardware to secure one collector.

Each set contains:

- (6) Two-piece hinge mounts
- (4) Triangle Mounting Feet
- (4) 1-3/4" x 3/8" -16 Stainless Steel Bolts
- (2) 4" x 3/8" -16 Stainless Steel Bolts
- (6) 3/8" -16 Stainless Steel Nuts
- (6) 3/8" Stainless Steel Washers

Installation Instructions

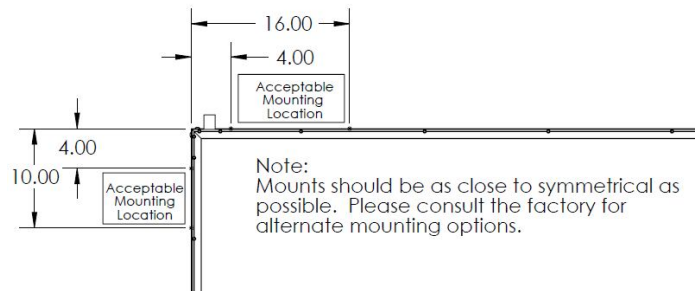
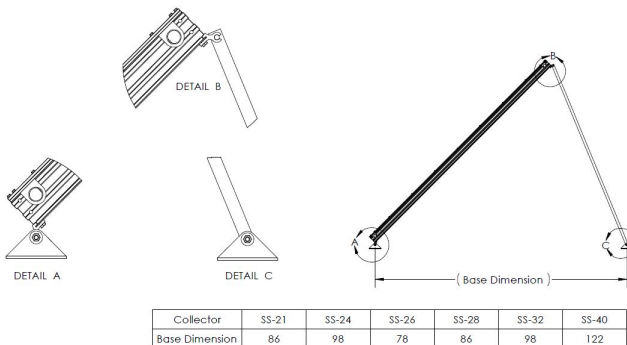

Mount triangle feet to structure or Uni-StrutTM at proper front-to-back spacing according to collector size

- Side-to-Side spacing should be in accordance with the diagram shown
- The triangle foot mounts can be fastened to Uni-StrutTM or directly to the asphalt roof using the appropriate fasteners and sealant



Front Mounts

- Slide apart the halves of the hinge mount

Solar Skies Mfg, LLC

106 Donovan Drive • Alexandria, MN 56308 • Ph 320-762-1151 Fax 320-762-1460

Hardware Instructions for North Star Series Collectors: MT-TM-SC (Tilt Mount) – Cont.

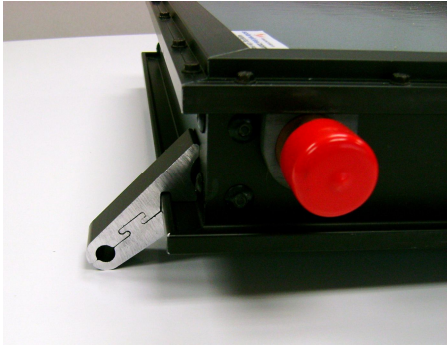

- Reassemble over the bottom frame rail lip
- Slide the hinge mount to desired location along the bottom side of the collector that will meet the roof

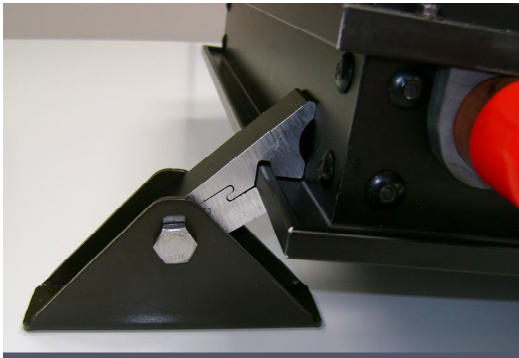

- Attach the triangle foot to the hinge mount with the 1.75" x 3/8" bolt, 3/8" nut and washer

Back Mounts

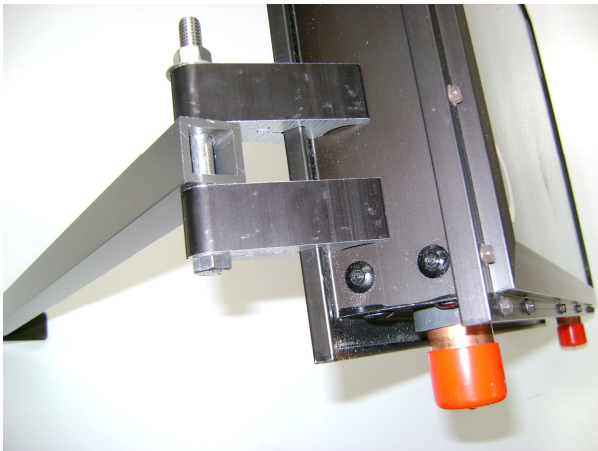

- Slide apart the halves of the hinge mounts
- Reassemble them over the top frame rail lip
- Slide the hinge mount to desired location along the top side of the collector what will be tilted up

Solar Skies Mfg, LLC

106 Donovan Drive • Alexandria, MN 56308 • Ph 320-762-1151 Fax 320-762-1460

Hardware Instructions for North Star Series Collectors: MT-TM-SC (Tilt Mount) – Cont.



- Leave a 1" space between the hinge mounts
- Position the E-1022 struts between the two hinge mounts on each side and align the hole in the strut with the holes in the tilt hinge.
- Insert the 4" x 3/8" bolt through all three pieces and secure with a 3/8" nut and washer

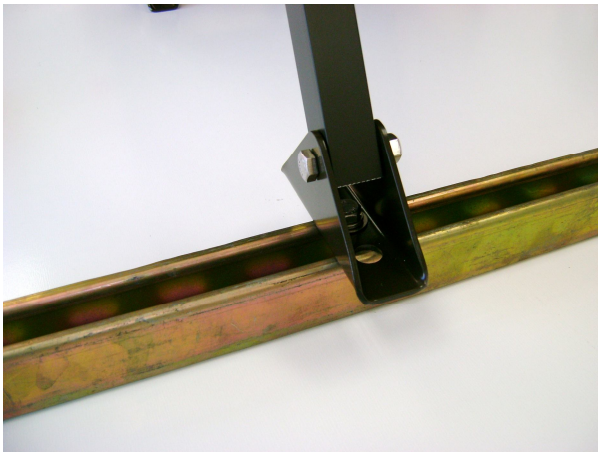

- Position the E-1022 strut into the triangle foot and align the hole in the strut with the holes in the triangle foot. Insert the 1-3/4" x 3/8" bolt and secure with a 3/8" nut and washer



- When all hardware and fasteners are installed, the assembly will look similar to the photo shown
- Check for collector alignment and tighten all fasteners

Solar Skies Mfg, LLC

106 Donovan Drive • Alexandria, MN 56308 • Ph 320-762-1151 Fax 320-762-1460